

# Robotic Pool Cleaner User Manual

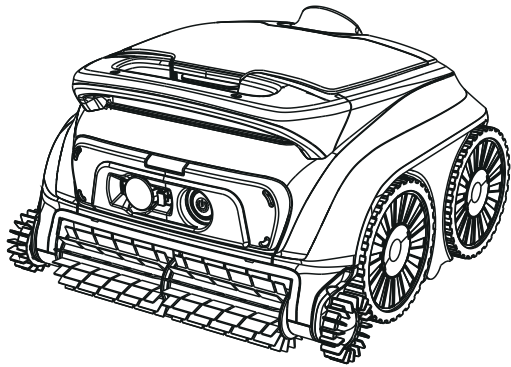

WYBOT B1

# WYBOT®

Read through the entire manual before running your new robotic pool cleaner, and keep this manual handy for your reference.

# WYBOT®

WYBOTICS CO.,LTD

No.30,Zhongnan 4th Street West Zone,TEDA Tianjin,China

All trade names are registered trademarks of respective manufacturers listed.

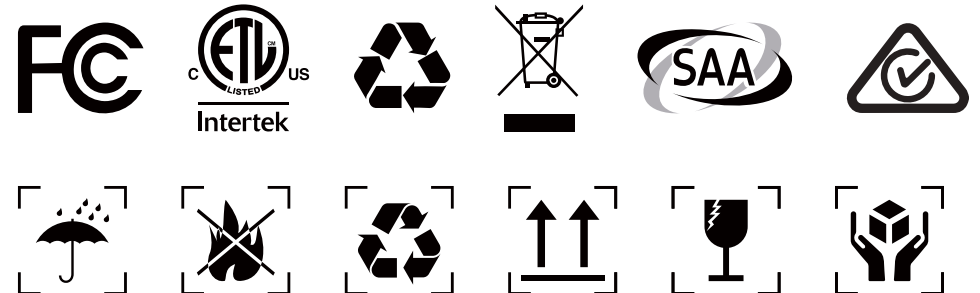



Dear Valued Customer,

Thank you for choosing WYBOT. We're glad to be part of your pool care routine.

WYBOT robotic pool cleaners are built to make pool maintenance simple and reliable. With smart navigation, powerful suction, effective scrubbing, and fine filtration, your robot is designed to deliver a thorough clean while using energy efficiently. Advanced features like intelligent dirt detection and adaptive cleaning paths help ensure consistent results across different pool shapes and surfaces.

At WYBOT, we focus on practical innovation. Technology that works quietly in the background so you can spend less time maintaining your pool and more time enjoying it.

If you have questions or feedback, we're here to help. Visit our website or contact our support team anytime.

Enjoy a cleaner pool with WYBOT, where technology meets convenience.

## Safety Instructions

### Warning

#### Important Safety Instructions

Read this manual carefully before using the cleaner. Failure to follow these instructions may result in serious injury, electric shock, or death.

Use and operate this product only as described in this manual. Improper use may result in personal injury or property damage. WYBOTICS Co., Ltd. is not held liable for any loss or injury caused by improper use.

#### General Safety

1. Use only accessories recommended or supplied by WYBOTICS Co., Ltd.
2. Use only the original, authorized charger provided with this product. Do not use the charger with any other devices. Improper use may cause overheating, battery damage, or leakage.
3. Turn off the robot before performing any maintenance or removing it from the pool.
4. Ensure the charging port is completely dry before connecting the charger.
5. The electrical outlet used for charging must be protected by a Ground Fault Circuit Interrupter (GFCI) or Earth Leakage Interrupter (ELI).
6. Do not use the charger if the cord or plug is damaged. Doing so may result in electric shock.
7. Do not use unauthorized extension cords or adapters with the charger.
8. Do not allow children to ride on the cleaner or use it as a toy.
9. Children must not operate or maintain the device or docking station.
10. Do not enter the pool while the robot is operating.
11. Do not expose the device or charger to flammable or explosive environments.
12. Sealed components may only be disassembled by licensed or qualified service professionals.
13. Any servicing beyond routine user maintenance described in this manual must be performed by a qualified professional.
14. Keep hands, fingers, hair, and objects away from moving parts during operation. Moving parts can cause serious injury.

#### Wireless Communication Notice

15. This device contains Bluetooth modules operating at 2.4 GHz and complies with applicable RF exposure standards. To reduce exposure, operate the device as instructed and avoid prolonged close contact with communication modules.

## Safety Instructions

### Cautions

Failure to follow these cautions may result in damage to the device or reduced product performance.

1. Fully charge the cleaner before first use.
2. Do not overcharge the cleaner. Overcharging may reduce battery lifespan.
3. Before long-term storage of six months or more, fully charge the cleaner to help maintain optimal battery health.
4. Do not operate the cleaner while the pool filtration system is running.
5. Rinse and clean the filter basket and ultra-fine filter after each use.
6. Store the cleaner in a cool, well-ventilated location away from direct sunlight or heat sources.
7. Operate the pool cleaner only in water conditions specified in this manual.

Chlorine	Max 4 mg/L
pH	7.0 - 7.8
Temperature	41 - 95 °F (5 - 35 °C)
NaCl	Maximum 5000 PPM

8. Before starting the robot, carefully inspect the pool liner. Do not use the cleaner if the liner is loose, damaged, folded, corroded, or if foreign objects such as stones are present. The liner must be repaired or replaced by a qualified professional before operation. Damage resulting from use in an unsuitable pool environment is not covered.

# CONTENTS

<b>01 / WYBOT AT A GLANCE</b>	<b>01</b>
Product External Overview	01
Product Internal Overview	02
Packing List	03
<b>02 / GET STARTED</b>	<b>04</b>
Charge your new WYBOT	04
Setup your new WYBOT	06
<i>Connect to your App</i>	06
<i>Customize your pool cleaning</i>	07
Run your new WYBOT	08
<b>03 / DO A FILTER CLEANING</b>	<b>10</b>
<b>04 / DEVICE SPECIFICATION</b>	<b>11</b>
<b>05 / LIMITED WARRANTY</b>	<b>12</b>
<b>06 / HOW TO MAINTAIN YOUR DEVICE</b>	<b>12</b>
<b>07 / FAQ &amp; TROUBLE SHOOTING</b>	<b>13</b>
<b>08 / CERTIFICATION</b>	<b>15</b>
<b>09 / WYBOT CUSTOMER CARE</b>	<b>15</b>

## 01 / WYBOT AT A GLANCE

### Product External Overview

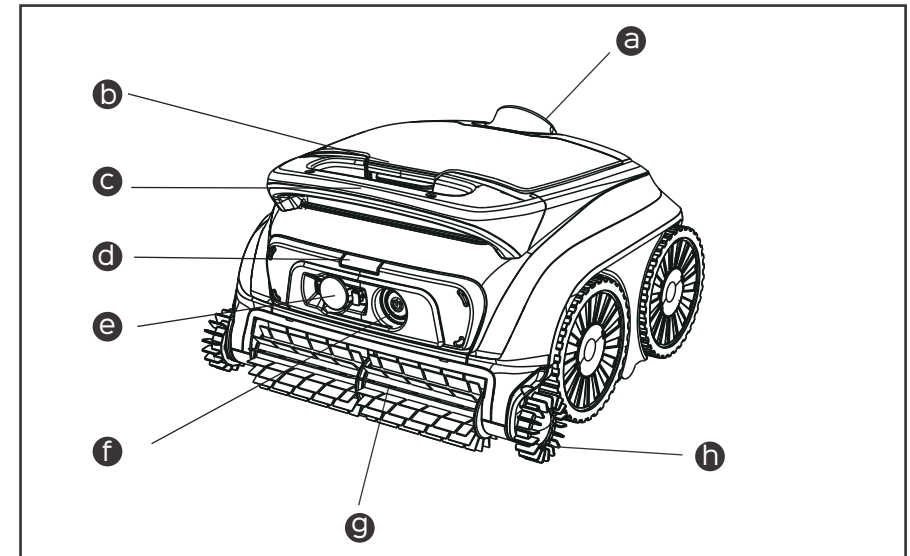

- |   |  |
|---|--|
| <b>a</b> <b>Pump</b><br>Discharges water from the unit during operation.                                  | <b>b</b> <b>Lid Open Button</b><br>Hold to open the top cover and access the filter assembly.                        |
| <b>c</b> <b>Handle</b><br>Used to lift, carry, and remove the cleaner from the pool.                      | <b>d</b> <b>LED Status Indicator</b><br>Displays operating, charging, and error status using different light colors. |
| <b>e</b> <b>Charging Port</b><br>Connect the charger to recharge the cleaner battery.                     | <b>f</b> <b>Power (On/Off) Button</b><br>Turns the device on or off.   |
| <b>g</b> <b>Front Scrubbing Brush</b><br>Loosens debris and directs dirt into the cleaner for collection. | <b>h</b> <b>Edge Scrubbing Brush</b><br>Cleans pool edges and corners during operation.                              |

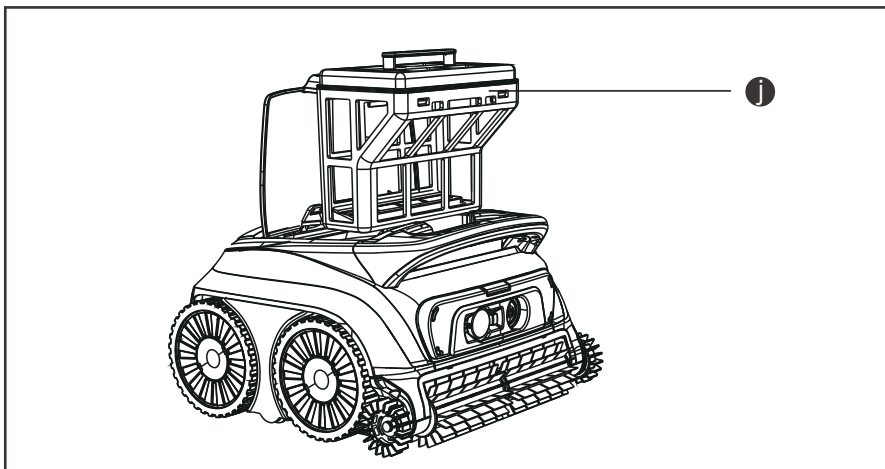

**i Filter Basket**  
 Store collected dirt and debris, remember to install it before start cleaning, and wash it after each use.

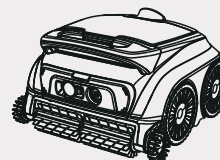

Device x 1

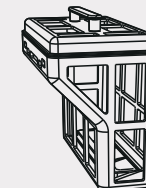

Filters x 1



Quick Start Guide x 1



User Manual x 1

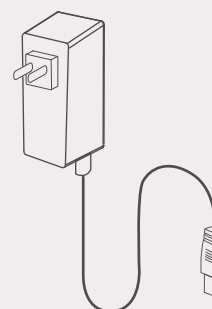

Charger x 1

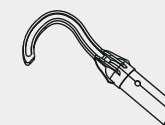

Hook x 1

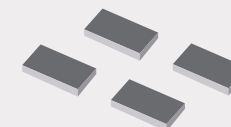

Floating Blocks

This device is powered by a built-in lithium-ion rechargeable battery. Fully charge the battery before first use and whenever the battery level is low.

Connect the cleaner to a wall outlet using the supplied charging cable and power adapter.

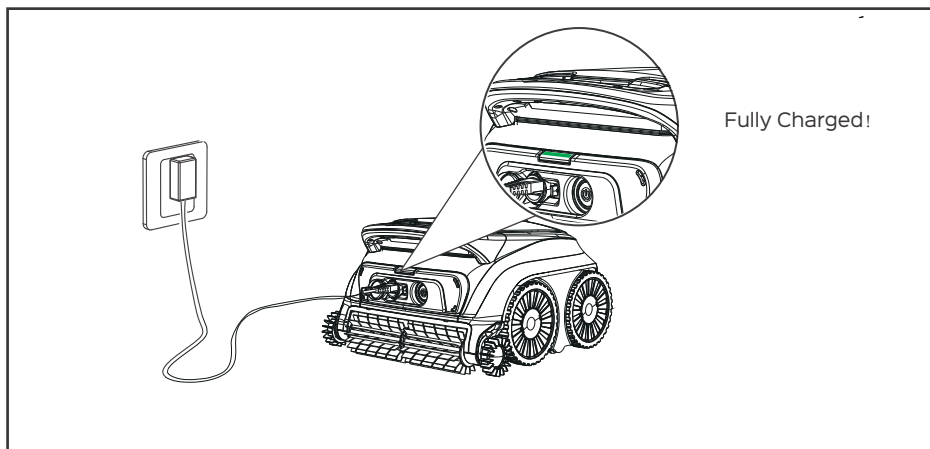

**Note:**

1. When charging, place the cleaner at least 3 m (10 ft) away from the pool edge.
2. To reduce the risk of fire or electric shock, keep the cleaner and power adapter away from water, moisture, and direct sunlight while charging.
3. Before charging, ensure the cleaner is powered off and the charging port is completely dry.
4. Charge the cleaner in an environment with an ambient temperature between 32°F and 95°F (0°C to 35°C) and relative humidity between 5% and 95%.

The power adapter is equipped with an indicator light that displays a solid blue light when power is supplied.

The LED indicator on the top of the cleaner will turn solid green when the battery is fully charged.

Refer to the table below for LED status indications.

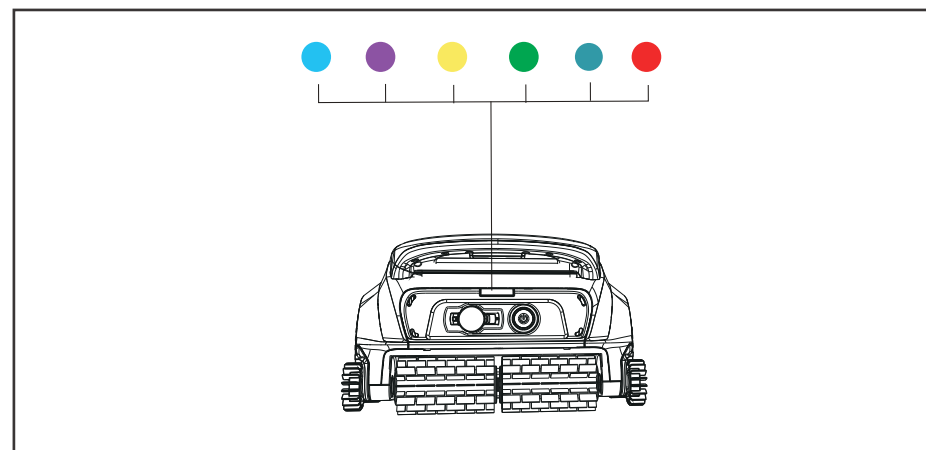

LED Light	Indication	Status
●	Solid	Power On
	Flashing	Cleaning
●	Solid	Connecting to App
●	Flashing	Low battery or self-parking in pool
●	Flashing	Charging in progress
	Solid	Fully charged
●	Solid or flashing	Fault detected
●	Flashing	Firmware upgrading

## 02 / GET STARTED

### Setup your new WYBOT

Turn on the device by pressing the on/off button. The LED indicator on the top will display a solid green ● to display current battery level and then a solid blue ● when the device is on. If the battery level is too low to start cleaning, the LED lights will show a flashing ● .

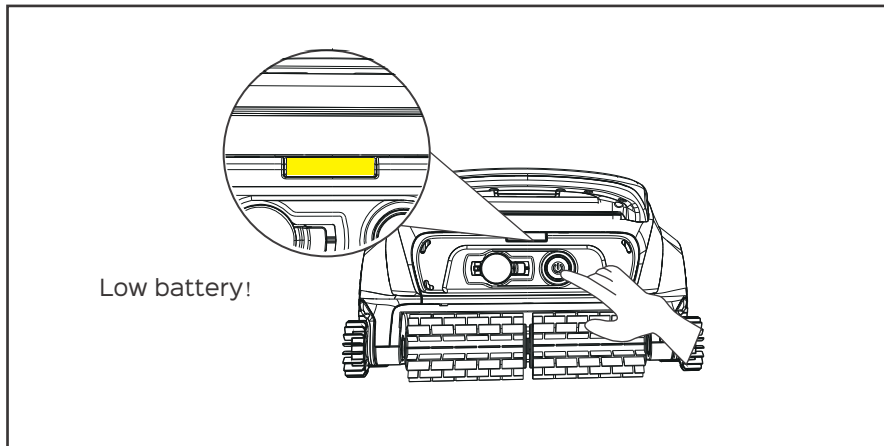

#### Note:

1. When yellow light flashes, you should charge the device immediately.
2. If red LED light is on, you can find solution from trouble shooting in this manual or call for service.

#### Connect to your App

Download the WYBOT App to your smartphone by scanning the QR code provided or by searching for WYBOT in the App Store or Google Play.



iOS	Android
iOS 17.0 or later	Android 8.0 or later

## 02 / GET STARTED

### Setup your new WYBOT

You may follow the steps below to customize your cleaning from the APP.

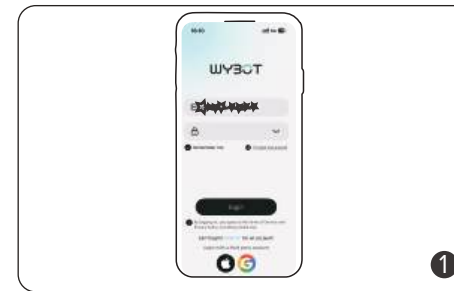

Sign up an account and log in.



Enter the home page and tap '+' to find the robot.

#### Note:

The robot can only connect to your mobile phone when it is out of water.

#### Choose your cleaning mode

Select a cleaning mode based on your pool type and cleaning needs:

Cleaning Mode	Cleaning Coverage
Standard full pool	Wall+ Floor+Waterline (Complex pool shape)
Floor only	Pool floors
Wall only	Pool walls
Waterline only	Pool waterline
Wall then floor (Combo)	Wall *1+ Floor *1 (Default)

#### Choose your cleaning time

You may customize cleaning duration via the app by choosing 'Quick cleaning mode'. In Quick Clean mode, the robot runs for about 1 hour, ideal for daily maintenance of smaller pools.

## 02 / GET STARTED

Run your new WYBOT

Please ensure the battery level is above 50% before starting. Low battery may reduce cleaning duration and coverage.



### Note:

1. You should modify your cleaning modes via App when out of pool. The default mode is Wall then floor
2. If the device restarts, it will automatically enter the cleaning mode you set last time.

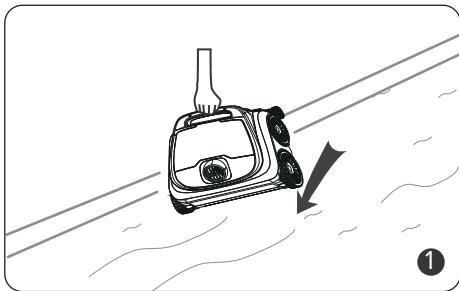

Hold the handle of the robot, and put it into the pool vertically.

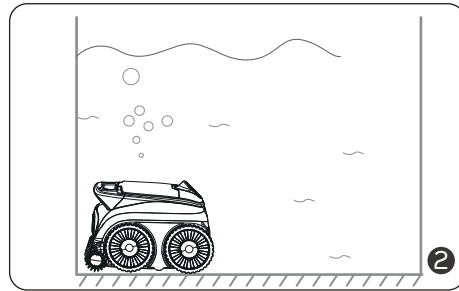

Let it sink down to the floor to empty trapped air inside.

### Note:

For best cleaning performance, the water level should be at least 15.75 in (40 cm) above the top of the device.

## 02 / GET STARTED

Run your new WYBOT

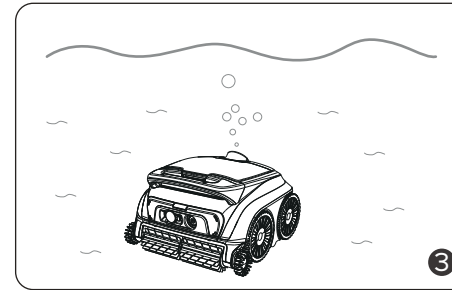

About 20 seconds of self-calibration, the indicator light will turn to be a flashing blue. The cleaner is ready to clean.

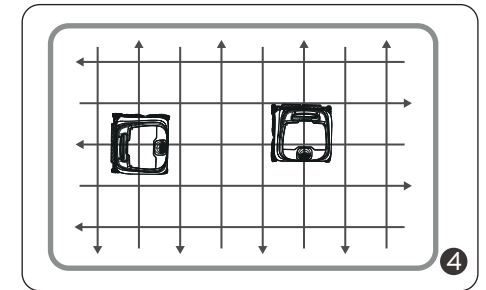

The cleaner begins to clean walls, floor and waterline as default or your set through App.

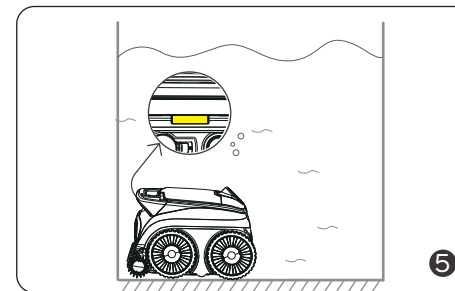

The device will automatically move to stop by the edge of wall when finishing cleaning or battery low.

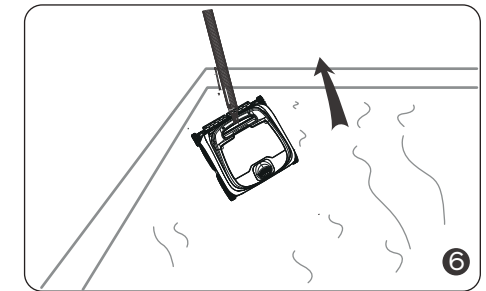

Insert the included hook into a pool pole and lift the cleaner out of the pool.

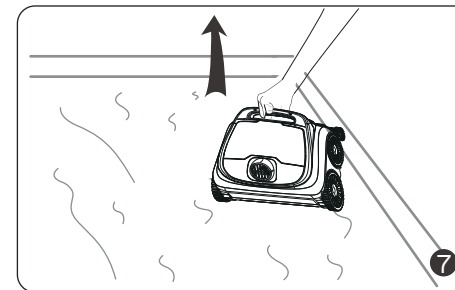

Take the cleaner out of the pool vertically to drain inside water out quickly.

## 03 / DO A FILTER CLEANING

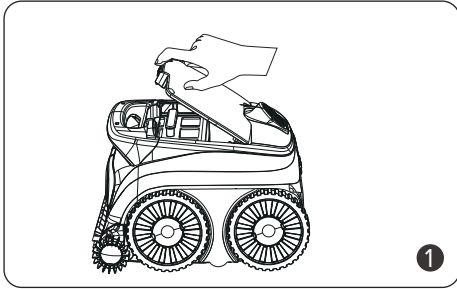

Hold the lid open button up to open the cover.

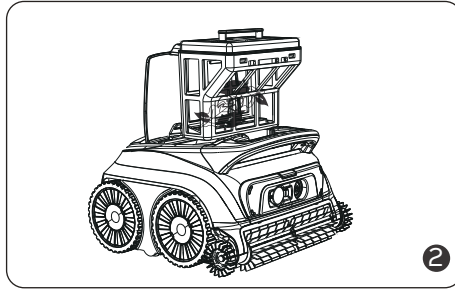

Take out the filter basket.

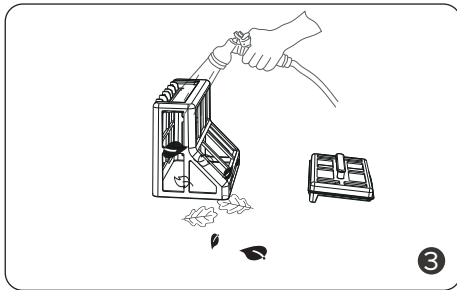

Empty all debris and rinse it with clean water.

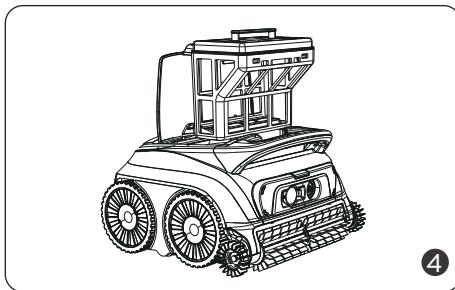

After rinsing, put the filter basket into the cleaner and close the cover.

### Note:

- 1.The cleaner contains electrical components. Store it in a cool, ventilated place, away from direct sunlight or heat sources.
- 2.If storing the cleaner for long periods (over 6 months), charge it beforehand to maintain optimal battery life.

## 04 / DEVICE SPECIFICATION

Basic Information	Product Name	WYBOT B1
	Model	OS600
	Net Weight	6.5kg
	Pool Size	Max 100m <sup>2</sup>
	Min Water Depth	40cm
	Max Water Depth	3m
Robot Configuration	Running Time Per Full Charge	100min~120min
	Charging Time (DC charger)	3 hours
	Power	35W
	Battery Capacity	2600mAh
	Filtration	180μm
Environment Requirements	Charging Environment	0 C -35 C (32 F -95 F) (5%-75%)RH Away from direct sunlight
	Storage Environment (off season)	5 C -45 C (41 F -117 F) (5%-75%)RH cool and ventilated place
DC Power Supply	Supply Unit Model	GM25-252100-1A (US)
		GM25-252100-2A (EU)
		GM25-252100-4A (AU)
	Input Voltage	100~240V AC
	Output Voltage	25.2V DC
Output Current	1.0A	
Connectivity	Bluetooth <sup>®</sup> Range Frequency	2402~2480MHz

## 05 / LIMITED WARRANTY

1. All WYBOT pool cleaners in the market have been inspected and licensed to be sold as per local laws.
2. The warranty applies only to original buyers, and not valid to resale and any other kinds of transfer.
3. Any damages to the unit caused by improper use, unauthorized repair or disassembly are not covered by WYBOTICS Co., Ltd.'s warranty.
4. The order number or record must be presented for any claim or repair within the warranty period.



Scan the QR code for the warranty policy.

## 06 / HOW TO MAINTAIN YOUR DEVICE

You should follow the steps to store your cleaner to maintain good performance.

- a) Make sure the device is powered off.
- b) Dry the cleaner and filter basket thoroughly.
- c) Fully charge the battery before storage.
- d) Store the cleaner in a cool, ventilated place, away from direct sunlight, heat sources, frost, or heavy pressure. Ideal ambient temperature is 5°C / 41°F to 45°C / 113°F.
- e) Recharge the battery every three months to maintain optimal battery life.

### Note:

If your device fails to operate after long periods of low battery or inactivity, contact Customer Care. Do not attempt to disassemble the device yourself for safety reasons.

## 07 / FAQ & TROUBLE SHOOTING

Q: What pool shapes and construction materials is the cleaner suitable for?

A: The machine can be applied to rectangle, oval, or irregular shapes of in-ground swimming pools. Applicable construction materials include PVC, gunite, tile and other materials. (Slippery materials such as tiles, mosaics, and acrylic may not work well, and you need to do some modification.)

Q: Will obstacles such as steps, shallow water areas, drains, slopes etc. in the swimming pool affect the running?

A: The machine can climb steps, drains, and shallow water areas. The above obstacles may influence its cleaning path, but will not affect the operation of the machine.

If you encounter issues while using the cleaner, refer to the troubleshooting table to solve them.

### Note:

If the solution isn't listed, please contact Customer Care for assistance.

## 07 / FAQ & TROUBLE SHOOTING

No.	Issues	Details	Possible Causes	Suggested Solution
1	Device does not work	A solid red light	Impeller is stuck	Check the impeller and clean foreign
		A flashing red light	Motor protection	Restart
		A flashing red light	Not put the device into the water or the pool water is too shallow	Restart and put it into the pool immediately. Be sure the water depth is over 0.4m.
		A breathing yellow light	Battery low	Fully charge the device and restart
2	Unable to charge	Charger light flashes	Poor contact	Re-plug the charger
3	Do not climb walls	Slippery construction materials	Slippery construction materials	Stick adhesive blocks (Contact after-sale team for instruction)
		Too dirty water	Too dirty water	Clean the filter basket
4	Abnormal wall climbing	Climbing slowly	Filter basket blocked	Clean the filter basket
		Sinking down away from wall or floating on the water	Intake air	Stick adhesive blocks (Contact after-sale team for instruction)
			Filter basket blocked	Clean the filter basket
5	only clean part area and cannot clean the entire pool	Wrong cleaning mode	Wrong cleaning mode	Connect to the App and re-choose a suitable cleaning mode
		Firmware not latest	Firmware not latest	Connect to the App and update the firmware
6	front side up when on the floor	Filter basket blocked	Filter basket blocked	Clean the filter basket
7	Do not clean as set cleaning path	Encounter Obstacles	Encounter Obstacles	Clean the filter basket
	stuck at water drains	Drain height is over 3cm	Drain height is over 3cm	Help the machine away from the obstacle
	Unable to connect to the App	Device power off	Device power off	Restart
8	The APP cannot be connected when the device is in the pool	Not available	Not available	Connect the device on the shore

## 08 / CERTIFICATION

WYBOT robotic pool cleaners have passed all performance and reliability tests and have obtained the relevant certifications in the countries where they are sold. You can use your cleaner with confidence.

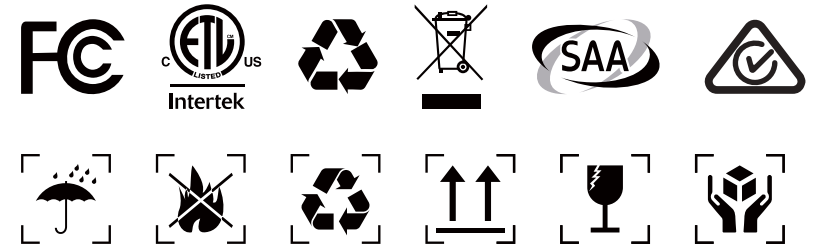

## 09 / WYBOT CUSTOMER CARE

WYBOTICS Co., Ltd. continuously improves its products. Specifications in this manual may differ slightly from the actual product, and WYBOTICS Co., Ltd. reserves the right to make updates.

If you encounter any problems during use, please contact after-sale team. For more details, please contact WYBOT website [www.wybotpool.com](http://www.wybotpool.com) (US), [www.au.wybotpool.com](http://www.au.wybotpool.com) (AU).

Wybot Customer Service:

Email: [support@wybotpool.com](mailto:support@wybotpool.com) (US)

[support\\_ca@wybotpool.com](mailto:support_ca@wybotpool.com) (Canada)

[support\\_au@wybotpool.com](mailto:support_au@wybotpool.com) (Australia)

Facebook: @WybotPool

Tel: 1-866-777-6655



Scan the QR code for the e-Manual.